

Installation instructions for PZ4AL-02672-00, PZ4AL-02673-00 Under Run Reduction Gearbox Protective Shield

LEXUS NX



Model Year: **NX200T - 2014 -** **NX200 - 2014 -**

Vehicle Code: **AGZ15L-AWTLTW** **ZGZ15L-AWXLPW**

Part Number: **Steel: PZ4AL-02672-00**
Aluminium: PZ4AL-02673-00



Weight: **Steel: 1,79 kg**
Aluminium: 0,83 kg



Installation Time: **10 min**

PZ4AL-02672-00, PZ4AL-02673-00

A

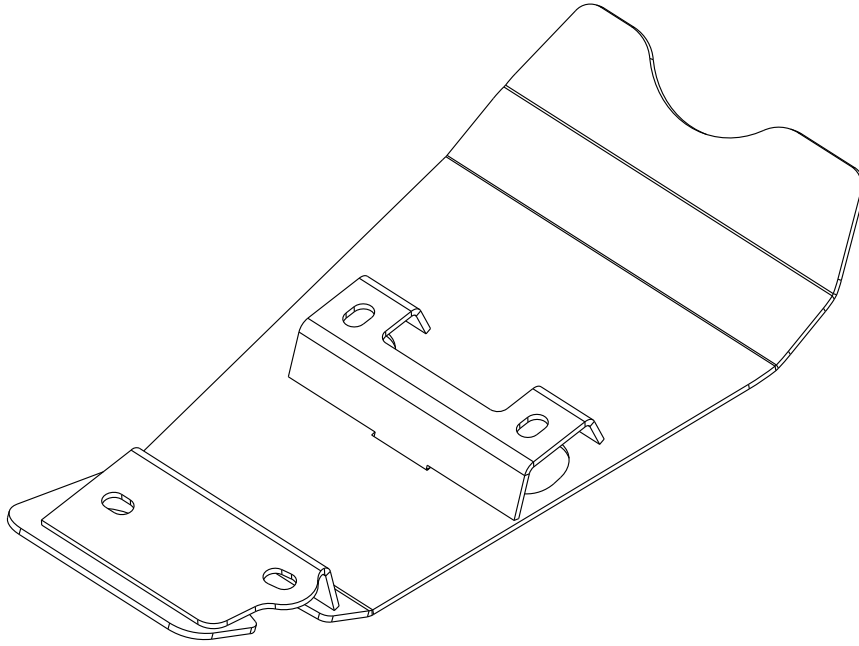

PZ4AL-08920-60

B

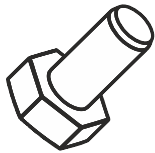

M8x20

4x

C1

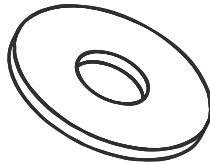

Ø 8

4x

C2

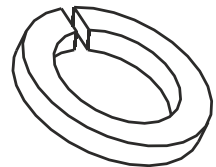

Ø 8G

4x

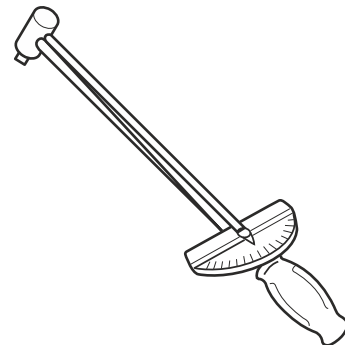
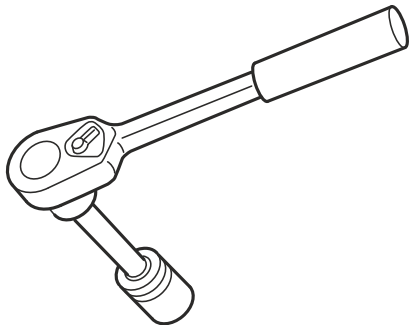

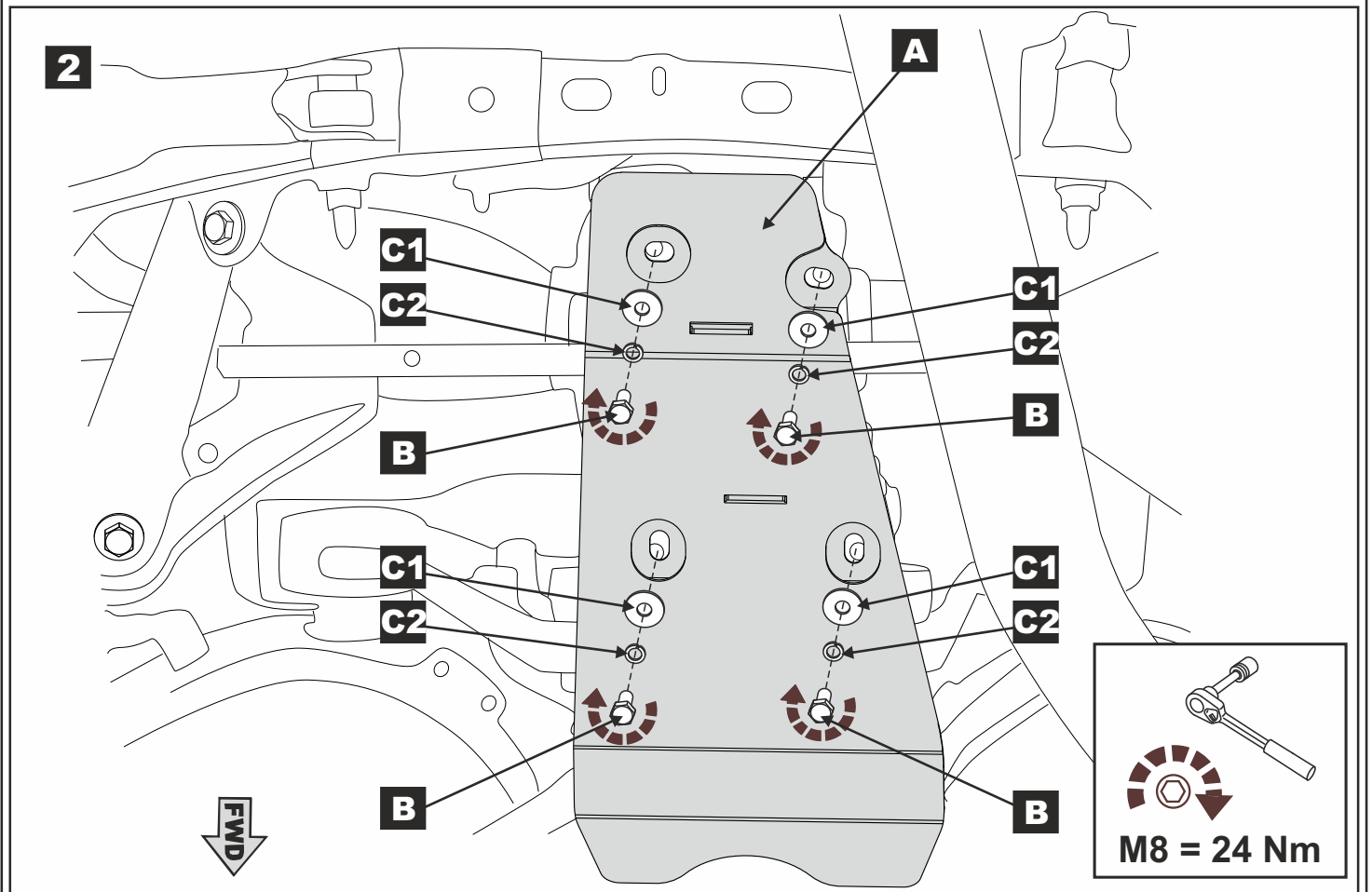
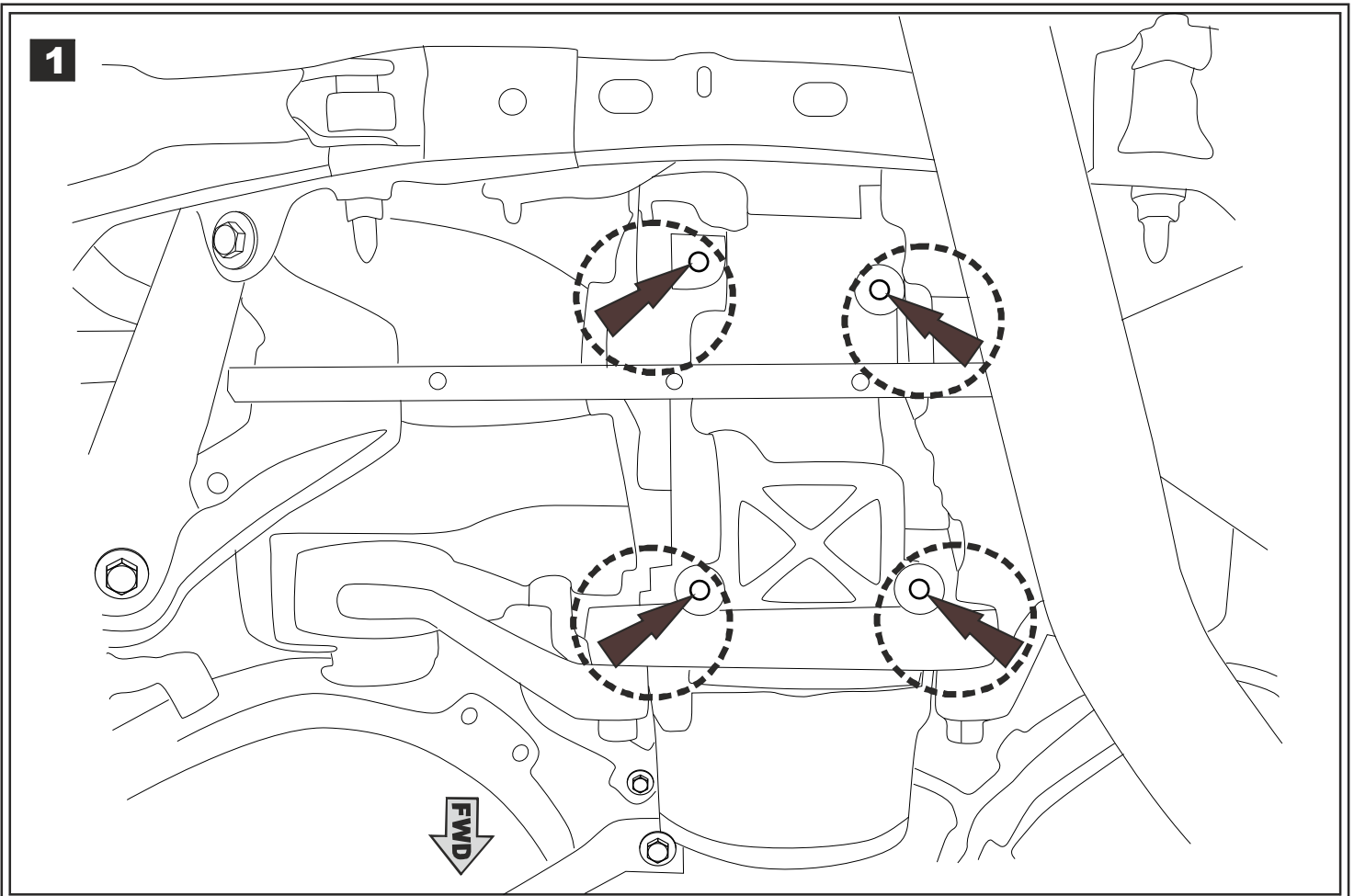

Part number:
PZ4AL-02672-00
PZ4AL-02673-00

Issue:
0

Date:
30/07/14

LEXUS NX 2014 -

Page:
3/4

3

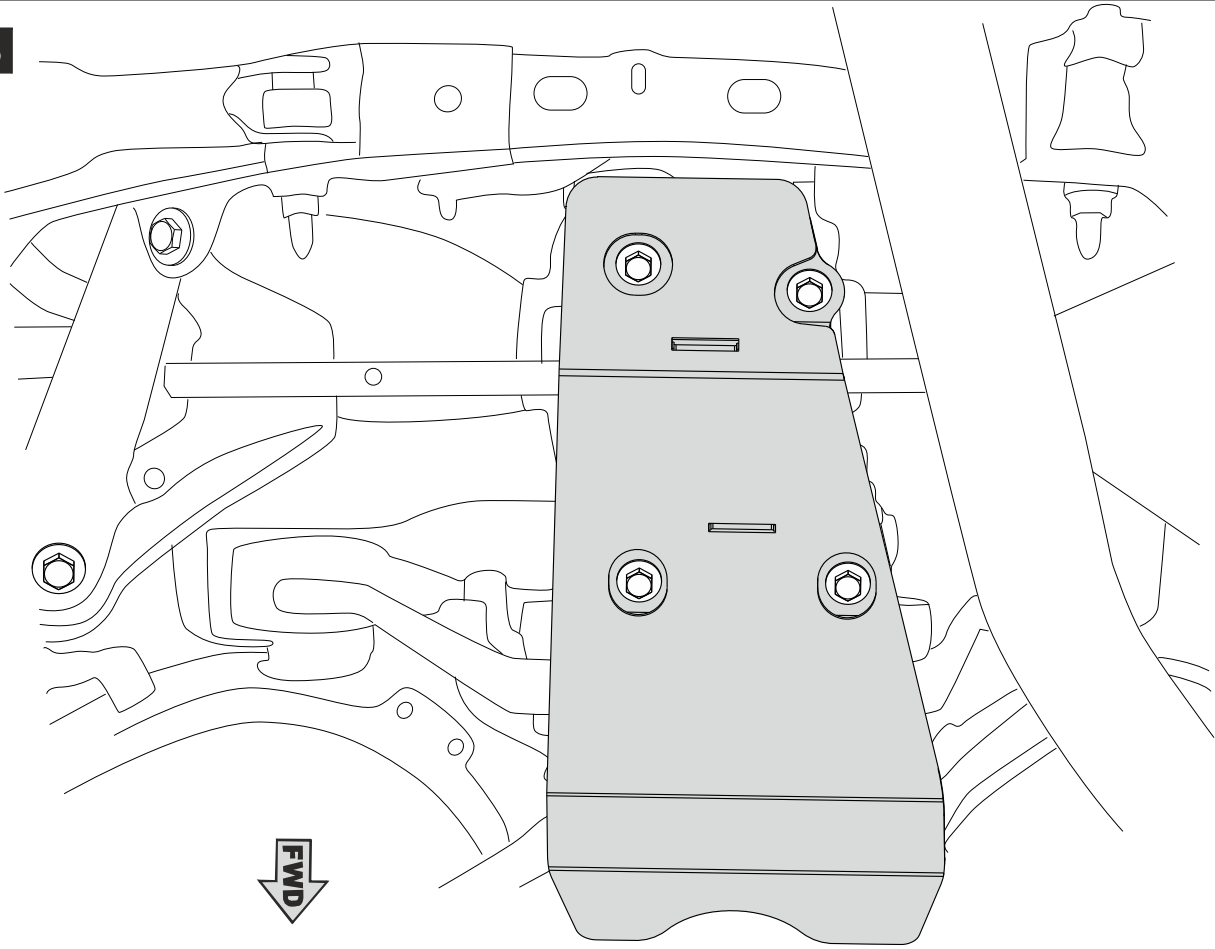

Part number:
PZ4AL-02672-00
PZ4AL-02673-00

Issue:
0

Date:
30/07/14

LEXUS NX 2014 -

Page:
4/4